



The complete range of  
**TECE** flushing technology

**TECE:**  
Intelligent housing technology



# There's a system behind it – flushing technology from TECE

## **As a system provider, TECE takes a holistic approach!**

Integration of the universal cistern in brick-wall and dry-wall construction modules is just as important as the flush actuation function in front of the wall. Every TECE push plate therefore fits every TECE cistern. The urinal flush valve completes TECE's flushing technology system. Our customers value and trust our know-how. The TECE cistern has proved its worth a million times over in long-term use.



### The TECE universal cistern – reliable and quiet

One excellent feature of the TECE cistern is its universality. The same cistern is used for every application scenario, whether you require operation from the top or front, a single or dual flush system, or different installation heights in brick-wall or dry-wall construction. The inner workings are largely identical and the spare parts are therefore always compatible.

The cistern is particularly quiet, as verified by several expert reports on sound insulation, from the Fraunhofer Institute among others.



# TECE cistern – advantages at a glance

## **Saving water when possible, flushing well when necessary!**

The new drain valve for the TECE cistern enables a real 4.5 litre full flush. Thanks to the dual flushing technology, a small flush requires just 3 litres.

Thanks to the combination of dual flush and 4.5 litre flush, the TECE cistern permits water savings of up to 50 percent, compared to flushing technology with 6 or 9 litres. Important for renovations: Because the drain pipe dimensions are often designed for large flush volumes, particularly in old buildings, the TECE cistern can be subsequently adapted to a 6 or even 9 litre full flush at any time. As a result, there are no blockages, even in old drain systems.

The TECE drain valve was awarded the Design Plus Prize 2009 for its water-saving technology and universal use.

**DESIGN PLUS**



Make sensible investments –  
in sustainable flushing technology  
from TECE.

## **Use in dry-wall and brick-wall construction**

The TECE cistern can be used universally: For dry-wall construction, it is delivered as a TECEprofil module, for brick-wall construction as TECEbox. Each range offers modules with a variety of installation heights.

Special modules round out the range: for example odour extraction on the toilet, or options for the installation of barrier-free toilets. There are new modules for installing washlets from TOTO.



TECEprofil module for dry-wall construction



TECEbox module for brick-wall construction

# New – the flush pressure can be not only reduced, but also increased.

The flush pressure can be flexibly adapted to any toilet regardless of the ceramics used. For example: After installation of the toilet, the ceramics are not flushed out correctly. With conventional drain valves, the flush pressure can only be subsequently curtailed, but not increased. The TECE valve has the solution to this problem: By exchanging the throttle ring installed as standard, the flush pressure can be subsequently increased. If there is overspray, it can of course also be reduced.

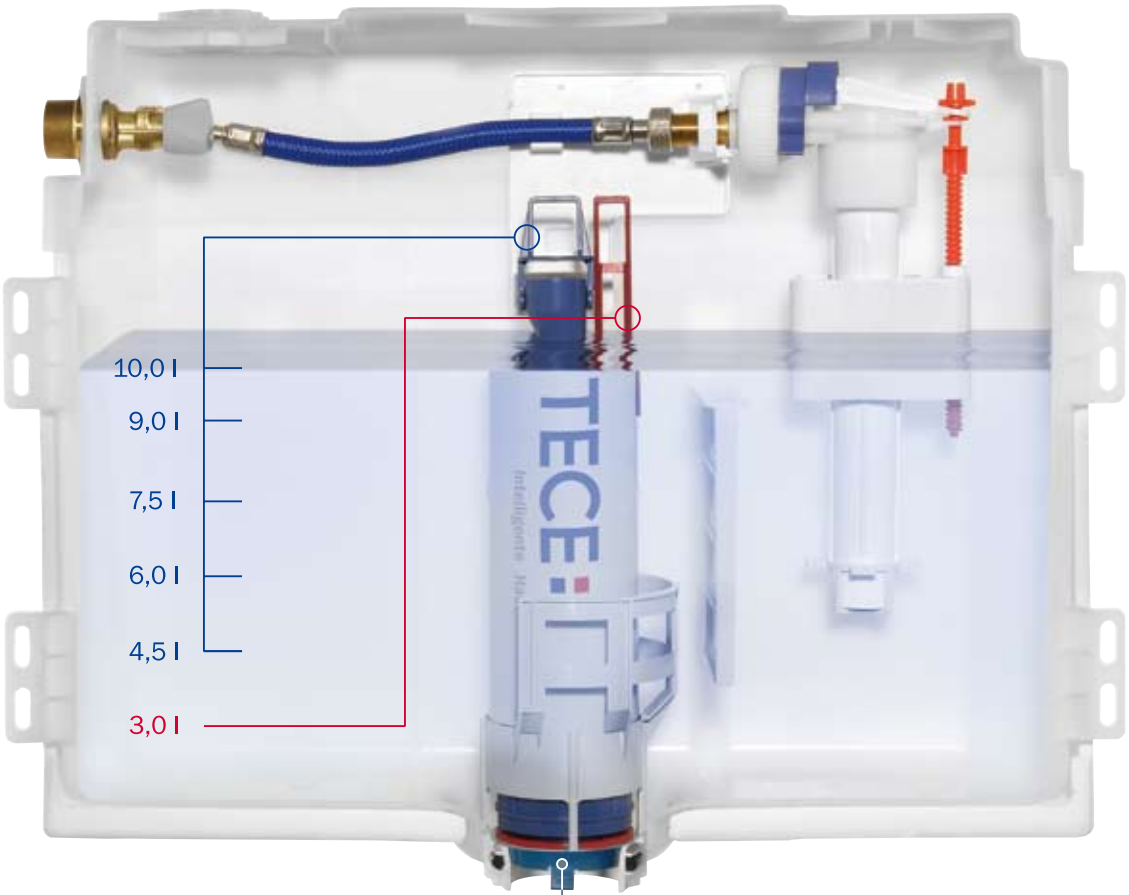

**Full flush:** 4.5/6/7.5 and 9 litres.  
**Reduced flush:** 3 litres

# TECE cistern

The red pull rod operates the reduced flush, the blue rod the full flush. The valve offers a choice between 4.5/6/7.5 and 9 litres for the full flush, while the reduced flush of 3 litres remains constant. With 4 throttle rings, the flush pressure can be flexibly set.



By replacing the throttle ring located in the valve seat, the flush pressure can be not only reduced, but also increased.

Maintenance is just as easy as assembly. When the valve is replaced, individual parts do not have to be removed or snapped out. The valve forms a unit in which all parts are permanently attached to each other.



The TECE cistern is pre-assembled ex factory and requires only the plumbing connections during the bare wall fitting stage. The cistern has to be opened only for the fine installation.



After the shell construction stage: The reinforced pipe is attached to the push fittings system on the filling valve with no need for tools.



The protective plate is a compact unit consisting of the splash guard, lever mechanism and fixing device.



Easy installation of the valves despite small inspection opening.



The actuation rods can be inserted quickly and accurately using the alignment marks.



For servicing, the entire engineering unit, including the lever mechanism, cover and fixing plate, can be removed. All settings are retained.

### TECEprofil toilet module with TECE cistern

The TECE cistern can be used universally: For dry-wall construction, it is delivered as a TECEprofil module. Thanks to its practical service brake, the module is easy to install. The TECEprofil range offers modules with various installation heights and special modules that round out the range - e.g. for odour extraction or for installation of barrier-free toilets. There are new modules for installing TOTO washlets.



**TECEprofil toilet module**  
Installation height  
1120 mm  
Front actuation



**TECEprofil toilet module**  
Installation height  
980 mm  
Front or top actuation



**TECEprofil toilet module**  
Installation height  
820 mm  
Front or top actuation

### The TECEprofil toilet module – suitable for every installation situation



TECEprofil pre-wall  
installation



Freestanding TECEprofil  
wall



Individual module instal-  
lation in front of a brick  
wall



Individual module instal-  
lation with height-adju-  
stable universal fixing



# TECE cistern – dry-wall installation

## The TECEprofil pre-wall system

Practically no other pre-wall system needs as few basic elements as TECEprofil. The system's simplicity makes it extremely flexible – and offers safety and reliability in both individual and large-scale projects. The range consists of toilet, washstand, urinal and bidet modules. With just a few basic elements, you can set up pre-wall installations, corner solutions and freestanding walls in bathrooms quickly and reliably.

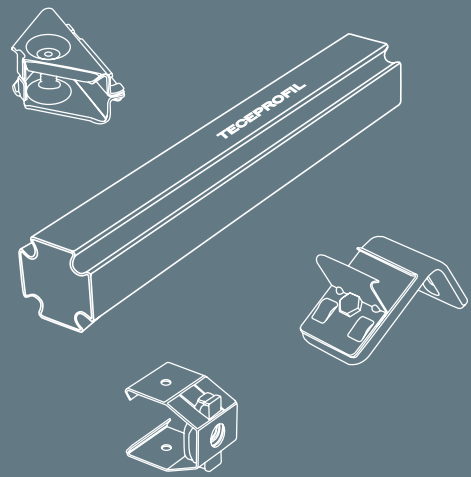

Corner construction:  
Installation with variable  
corner fixing



Metal post-and-beam UA  
profile wall, suitable for  
disabled people and  
senior citizens



Metal post-and-beam C  
profile wall



Wooden post-and-beam  
wall

# TECEbox – brick-wall construction can be this easy: seal in, tile, done.

For the installation in a bricked pre-wall installation. The tried and trusted TECE cistern is also used in the TECEbox modules. A galvanized steel frame is used as the installation frame.

## TECE brick-wall modules for toilet and washstand



### TECEbox brick-wall module

For front actuation. Ideal for assembly in rows by fixing directly with angle brackets and TECEprofil tube.



### TECEbox brick-wall module 820 mm

Depth-adjustable. Depending on assembly, it can be used for front or top actuation. Front tile base made of 30-mm structural board.



### TECEbox plus – brick-wall module

With height-adjustable bases, assembly area cover.



### TECEbox brick-wall construction frame for washstand

With depth-adjustable wall fixing. Installation height 8–18 cm.

# TECE cistern – brick-wall installation

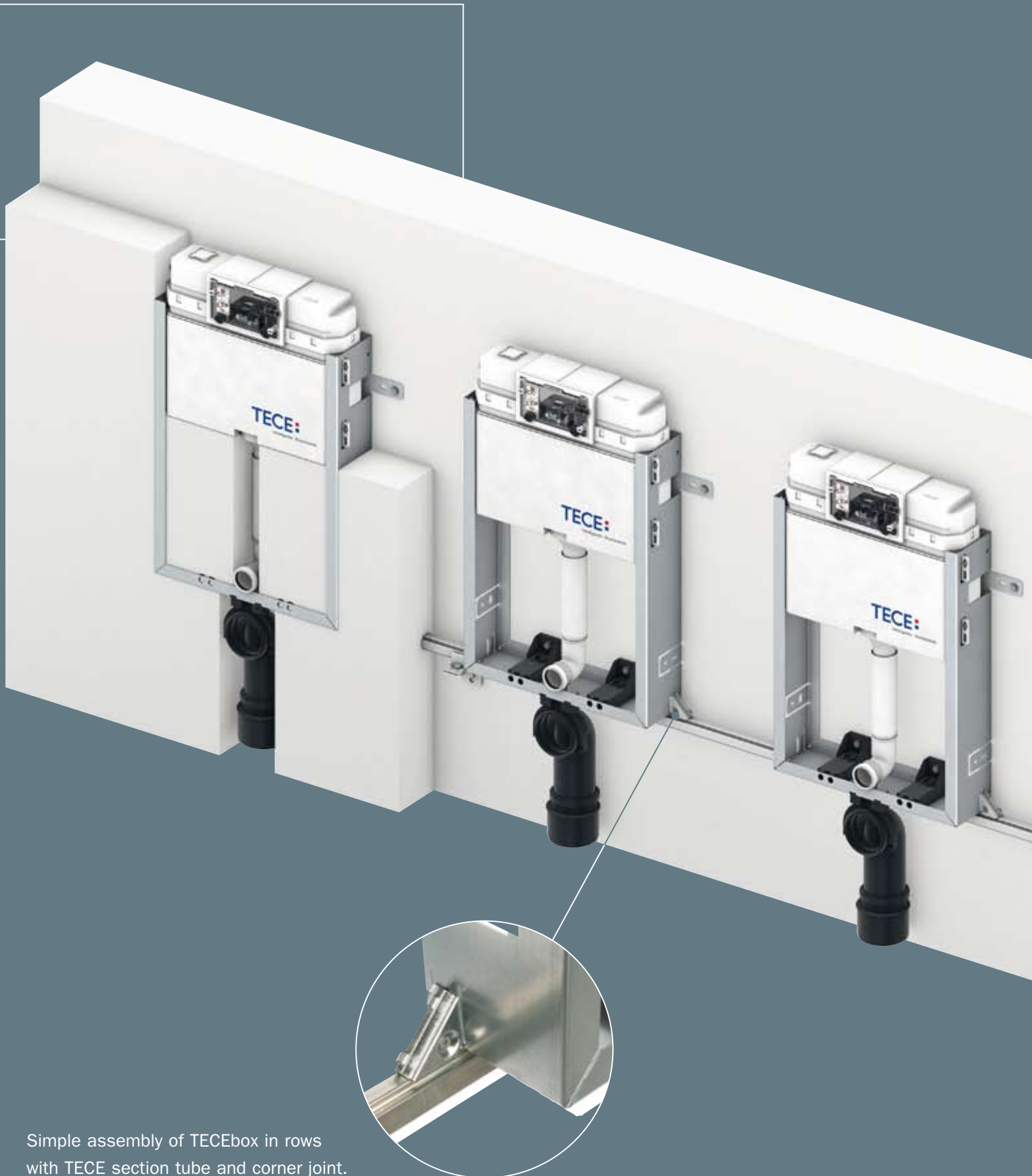

Simple assembly of TECEbox in rows with TECE section tube and corner joint.

**The 8 cm concealed cistern – 9.5 litre reliability**

The 8 cm concealed cistern is extremely flat and thus ideal for installation in thin masonry. The design is based on German know-how and is the product of many years of TECE experience in the field of flushing technology. For installation, the cistern is delivered as a TECEprofil module for dry-wall construction or TECEbox for brick-wall construction.



# TECE 8 cm concealed cistern

## TECE 8 cm cistern – A view inside.

The 8 cm cistern has a 9.5 l flush volume, which can be controlled by the water-saving single and dual flushing technology of the flush valve. This means that a second flush is possible even after a full flush of 9.5 litres. The cistern is filled via a low-noise hydraulic filling valve. The cistern is completely pre-assembled and sealed ex factory. An intact seal therefore means a complete and clean cistern and a closed corner valve – the cistern does not need to be opened for the pressure test. As standard, the drain valve is set to 3 litres for the reduced flush and 6 litres for the full flush.

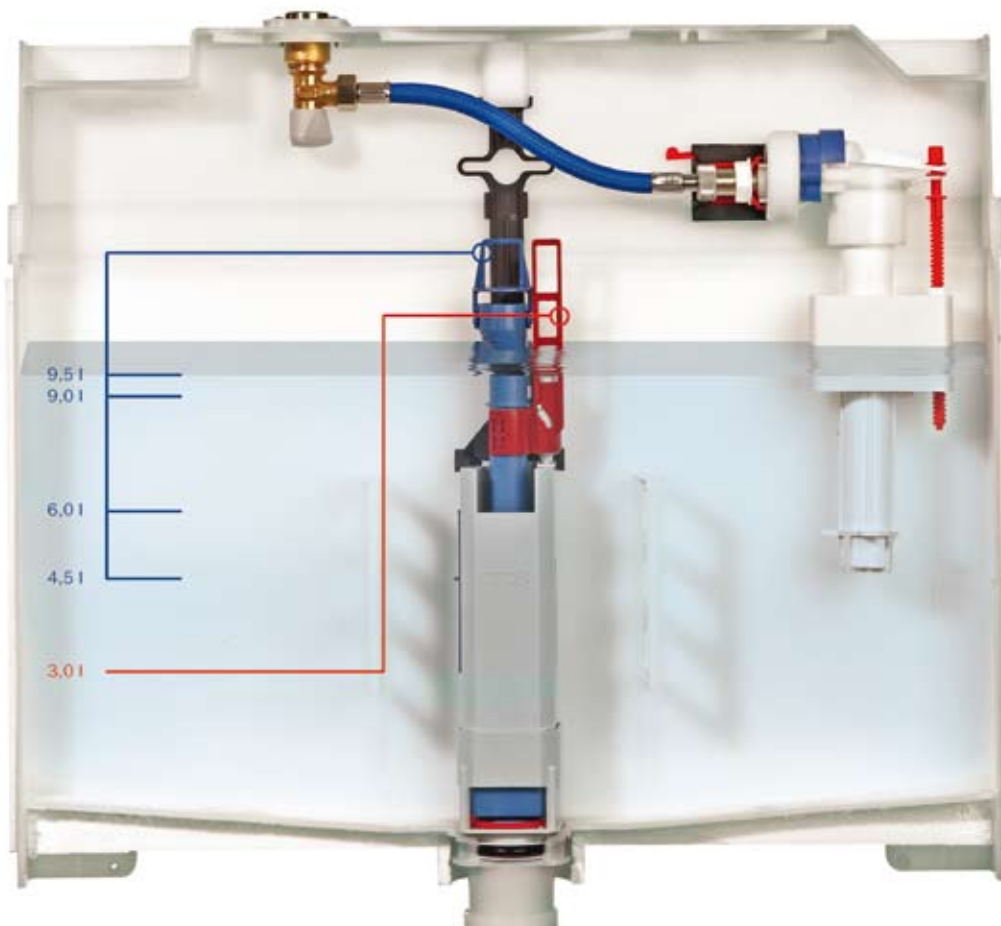

**Full flush:** 4.5/6 and 9 litres  
**Reduced flush:** 3 litres

The red pull rod operates the reduced flush, the blue rod the full flush. The valve can be set to a full flush of 4.5/6 and 9 litres at any time using the slider on the side, while the reduced flush of 3 litres always remains constant.



When the valve is exchanged, no individual parts need to be taken apart or unscrewed, because the 8 cm valve also forms a unit in which all parts are permanently attached to each other. The valve can then be removed from the cistern by bending and turning.



The cistern is sealed and the reinforced hose has to be plugged on the filling valve without tools.



The cover plate is a compact unit consisting of splash guard, lever mechanism and fixing device, which can be removed easily.



After the shell construction stage the reinforced hose has to be plugged on the filling valve without tools.



For servicing the complete unit including the pushbutton unit can be removed. All settings are retained.



Once the hold-down device has been disconnected and removed, the valve can be lifted out of the valve seat and the pull rods bent towards the opening.



The valve can then be removed from the cistern by turning.



The valve seat can be removed easily using the hold-down device.



The filling valve can also be removed thanks to the intelligent filling valve holder.

# Installation variants

## TECEbox brick-wall cisterns and TECEprofil module

The 8 cm toilet module range comprises four mounting variants for all conventional mounting situations. All these modules use the 8 cm cistern from TECE. It is pre-assembled and sealed, has a 9.5 litre flushing volume, is insulated against condensate water and fitted with a water-saving dual flush system. The cistern is compatible with all TECE push plates (TECEsquare, TECEloop, TECEplanus (without toilet electronics), TECEambia, TECEbase and toilet flush handles) and can be used as single flush or dual flush cistern depending on the push plate. The 8 cm product range is completed with the bidet and washstand modules which can be mounted in a wall or in front of a solid wall.



**Brick-wall cistern  
TECEbox basic**  
With adjustable flush pipe protected against condensate water. For floor-standing toilets.



**Brick-wall construction  
cistern TECEbox**  
For wall-hung toilets



**Brick-wall construction  
cistern TECEbox plus**  
For wall-hung toilets,  
sound-insulated



**TECEprofil toilet module**  
To be mounted in metal and wooden post-and-beam walls or in front of solid walls

## TECE 8 cm modules – possible mounting situations



Installation in a brick wall



Installation in a pre-wall installation



Individual module installation in front of a brick wall



Mounting in a metal post-and-beam C profile wall

A photograph of a modern bathroom. In the foreground, a white toilet is visible. The wall behind it is white and features a square, recessed push plate with two circular buttons. To the right, a window with a dark frame is partially visible, showing a bright outdoor scene. The overall lighting is bright and clean.

Always compatible –  
the push plates from TECE.



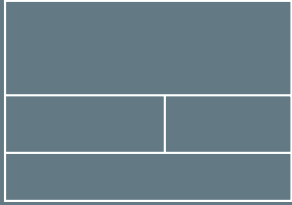

TECEsquare

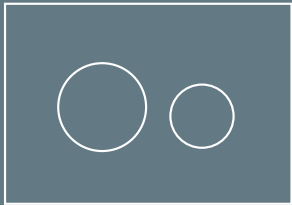

TECEloop

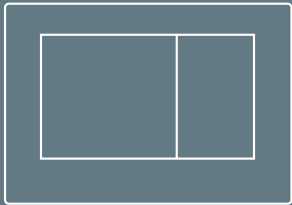

TECEplanus

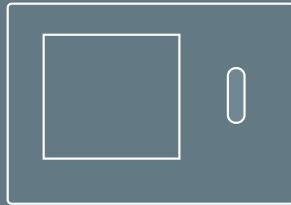

TECEplanus with IR sensor  
(Not compatible with 8 cm cistern)

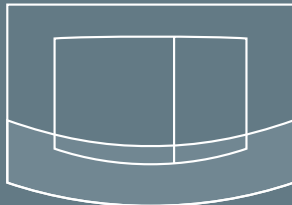

TECEambia

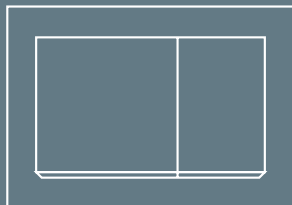

TECEbase

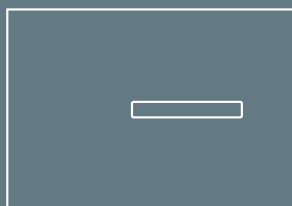

Flush handles

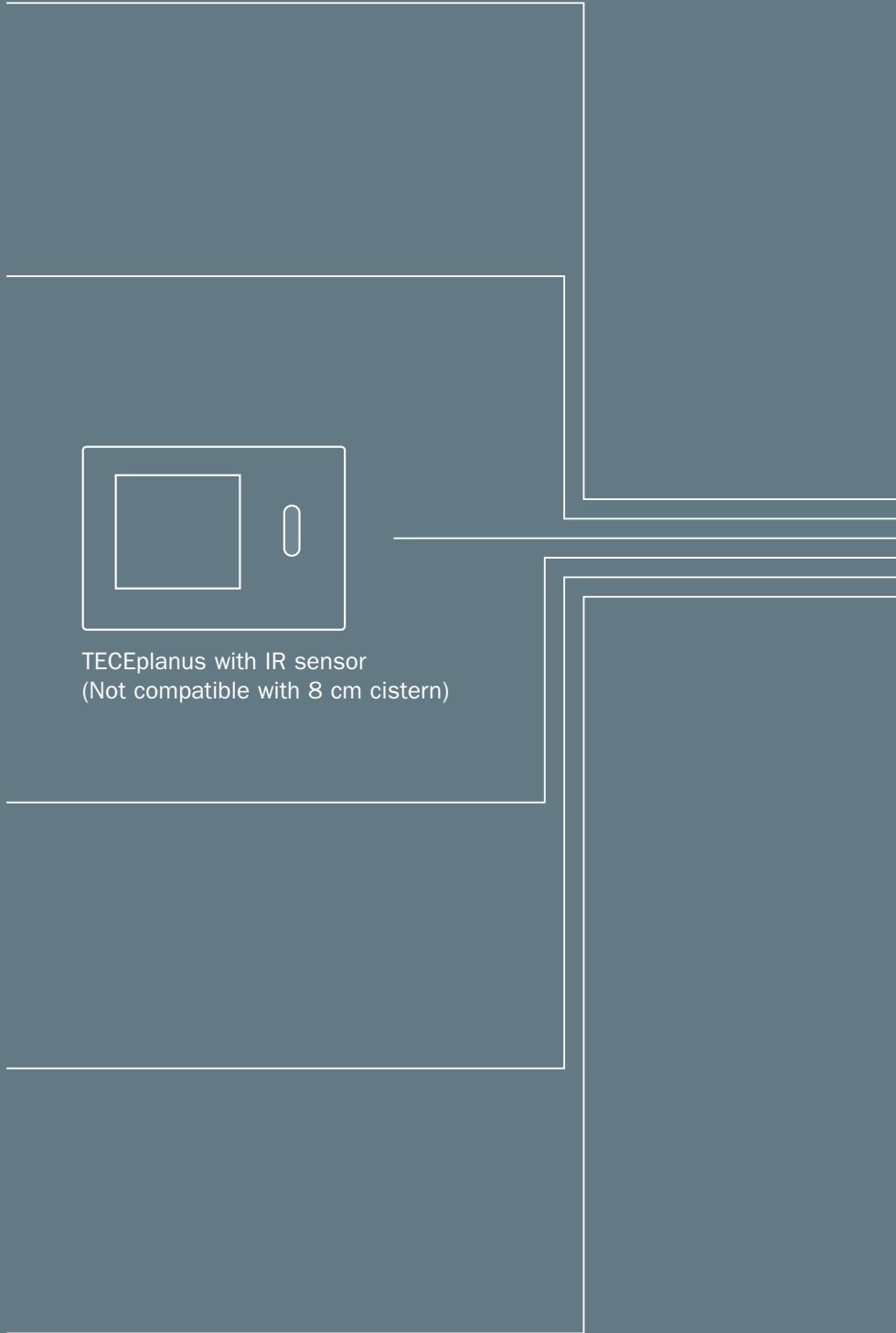

# There's a system behind it – flushing technology from TECE

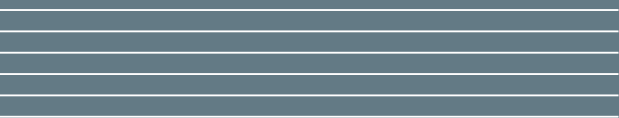

**TECE cisterns and TECE push plates are always compatible with one another!**

Selection of the right toilet push plate is really not that easy with some cistern manufacturers. Even if the push plate and cistern come from the same manufacturer, it doesn't necessarily mean that they will fit together. It's different with TECE, where selection of the right toilet push plate is not a problem. If you like the look of it, and it's from TECE, it will be a perfect fit!

For more information on TECE push plates, see the brochure "The complete range of TECE push plates", or visit our website at [www.tece.de](http://www.tece.de), where you can use our Internet configurator to easily and conveniently look for the right push plate for your personal bathroom.

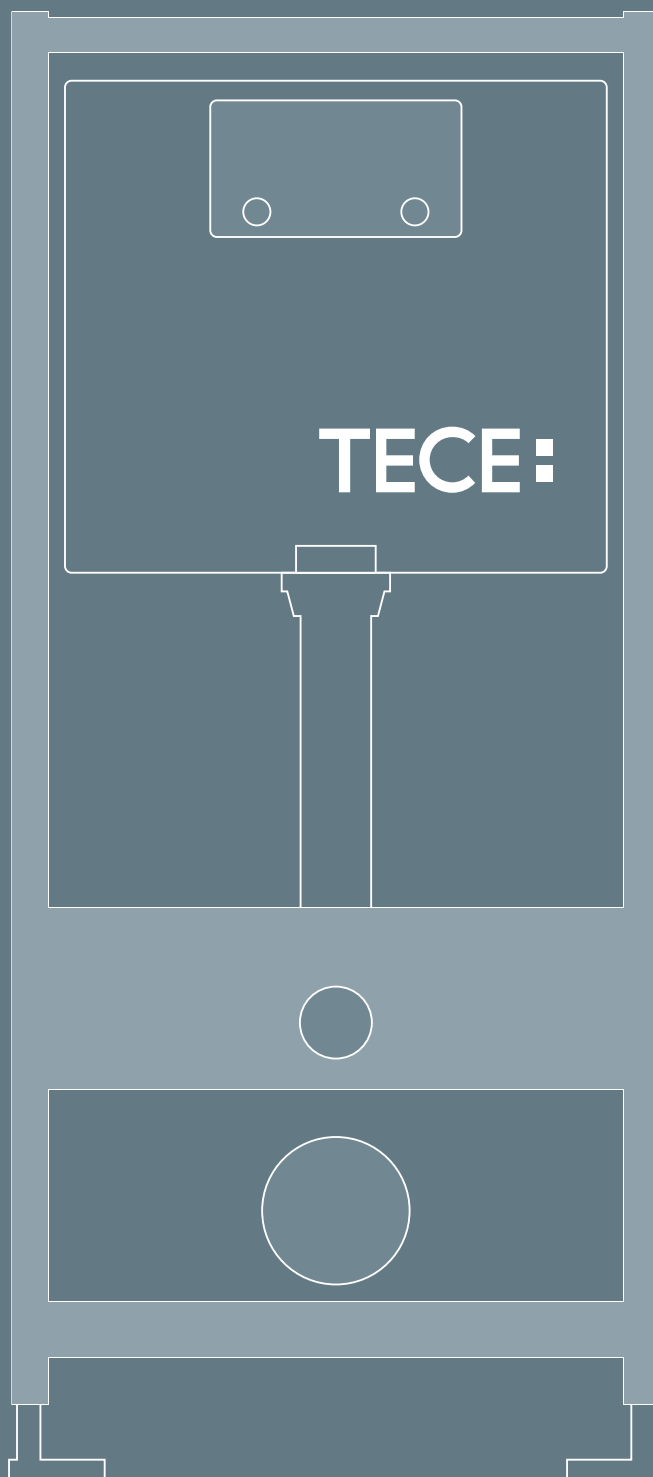

Toilet module

# TECE push plates for toilet and urinal

## Exclusively for the TECE cistern

Thanks to the special design of the cistern, toilet push plates from TECE are relatively small. As a result, they integrate unobtrusively in the bathroom architecture. TECE puts great value on a good form, even in the basic range for private and commercial projects, as demonstrated by the TECEambia, TECEbase and TECEplanus series. The stainless steel plates from TECEsquare and the glass fronts of the TECEloop series offer elegance for high-class bathrooms.

Toilet and urinal push plates with the same design are offered in the TECEloop, TECEplanus and TECEambia series.

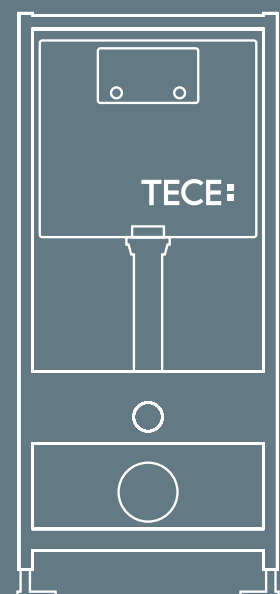
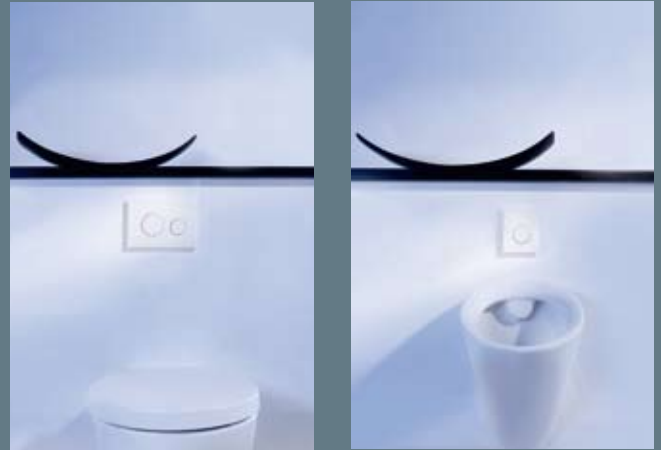

## Flush-mounted installation

The glass fronts of the TECEloop and TECEsquare can be installed flush to the wall. TECE offers a special installation frame for this.

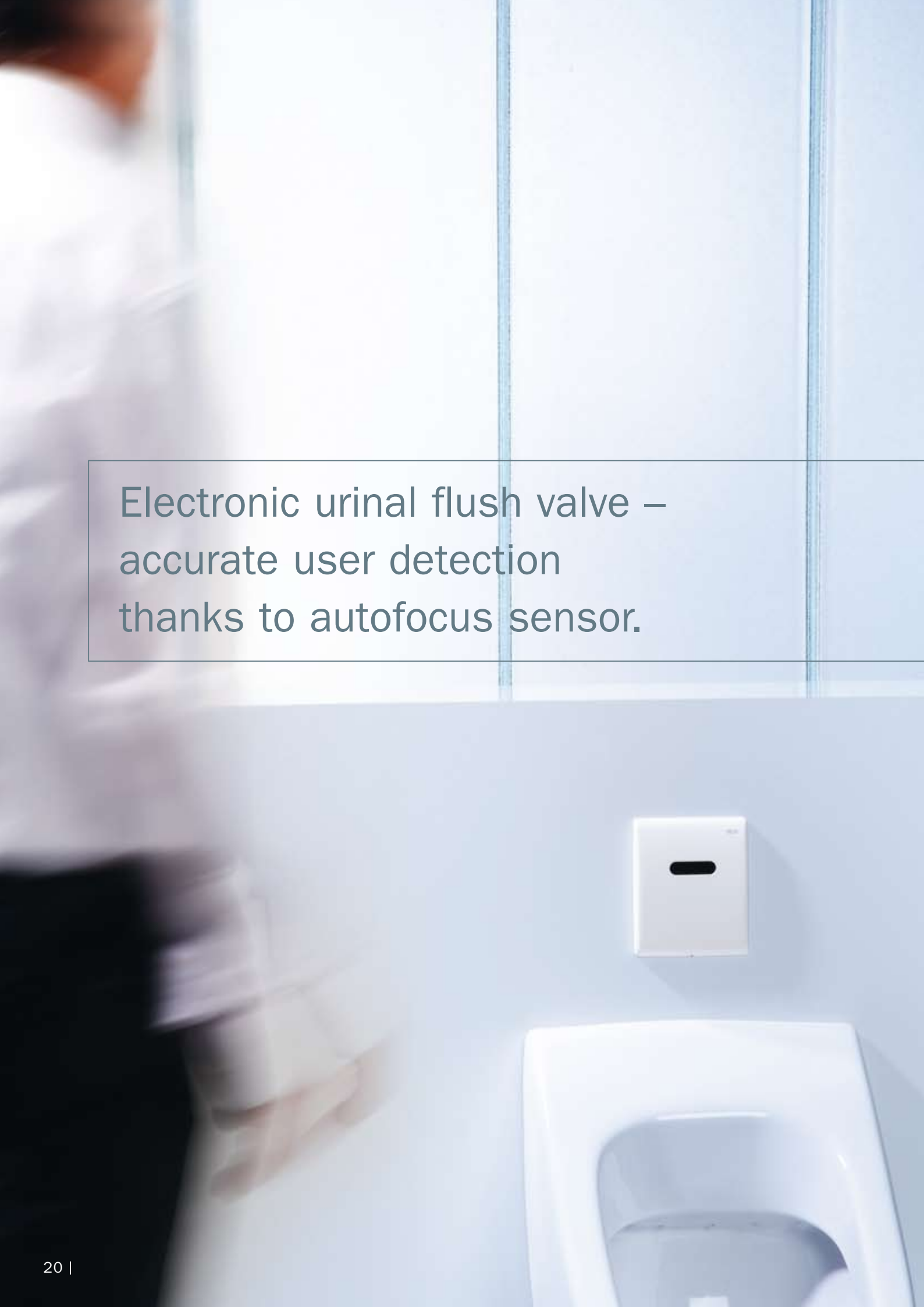

Electronic urinal flush valve –  
accurate user detection  
thanks to autofocus sensor.

# Electronic urinal flush valve from TECE

**The TECE electronics for non-contact flush actuation are based on an infrared sensor with autofocus.**

The sensor measures the angle of incidence of the light that a person reflects and measures the person's distance from the urinal – whether they are approaching or moving away. Thanks to this accurate analysis, flush actuation by mistake is reduced to a minimum. The situation is quite different with simple IR sensors: Here, flush actuation is controlled only by the volume of light that a potential user reflects. Pale clothing on a person passing by is enough to actuate a flush, and the consequence is high water consumption.

The TECE autofocus sensor uses intelligent PSD technology (unique position sensitive detection) to determine a person's exact location, and the sensor's good black detection means that actuation is not determined by the colour of a user's clothes. The sensor's insensitivity to changing lighting ensures accurate flush behaviour.

The energy consumption of the TECE electronics is minimal: The battery only needs to be replaced after two years or 500,000 flushes. Mains solutions are available for the TECEplanus urinal push plate.

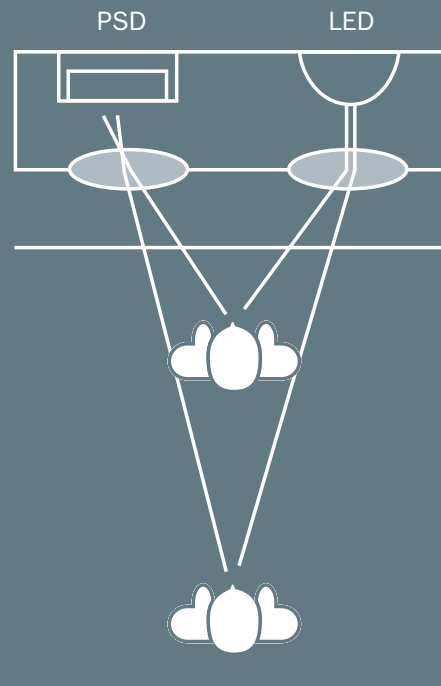

TECE PSD technology that screens out background details; method of operation

# Time-controlled flush actuation to reduce water consumption and cleaning effort.

**TECE has fitted its urinal electronics with a break-time function. School example: With this technology, urinal water consumption can be reduced by up to 40 percent.**

**Break-time function\*:** If the urinal is used at intervals of less than 2 minutes, the system switches to economy flush. A cleaning flush is actuated 45 minutes after the last economy flush.

**Cleaning function:** As the automatic flush is a nuisance during cleaning, the flush can be delayed by 10 minutes.

**Preflush\*:** Wets the ceramics for up to 2 seconds prior to use, helping to prevent the urine from sticking.

**Variable flush time:** The flush volume can be adjusted over the flush period (2 to 10 seconds) in accordance with individual requirements.

**Distance:** The optical recognition range can be manually altered for extremely small or large urinal facilities.

**Hygienic flushing\*:** Removes odours, stops the accumulation of residues, and prevents the siphon from drying out. Can be set to 24 or 255 hours after the last flush.

**Top-up function\*:** Today's urinals automatically drain the siphon and top it up with water. The TECE electronic system's top-up function can also be activated for added reliability. A short flush pulse fills the siphon up again.

(\*functions can be set on an optional basis)

# Electronic urinal flush valve from TECE

In programming mode, the electronic system can be set using a magnetic key. In standard operating mode, this key can be used only to activate the cleaning function.

**The break-time function automatically reduces the water volume.**

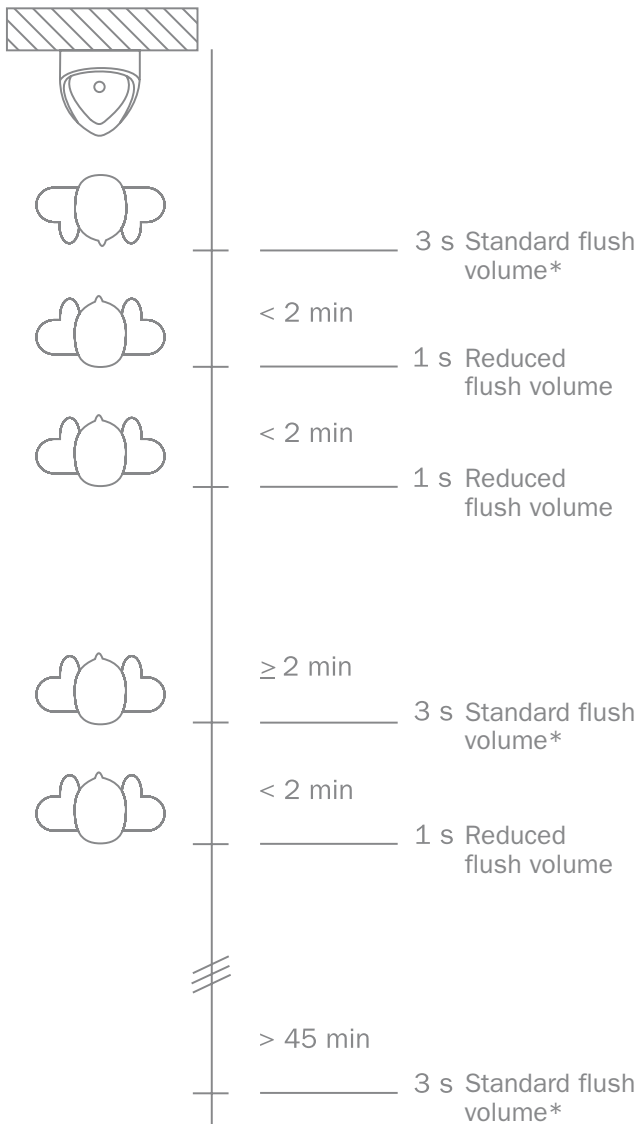

\* Standard flush volume can be set from 2 to 10 seconds



Electronics are easy to program using a magnetic key and programming list.

### The urinal flush valve – enhanced by TECE with state-of-the-art technology

A constant volume of water even if the flush pressure varies - TECE has made enhancements here and created a market-compatible flush valve with state-of-the-art technology. The flush valve is controlled hydraulically, is robust and reliable. An automatic jet cleaning function ensures maintenance-free operation over the long term.

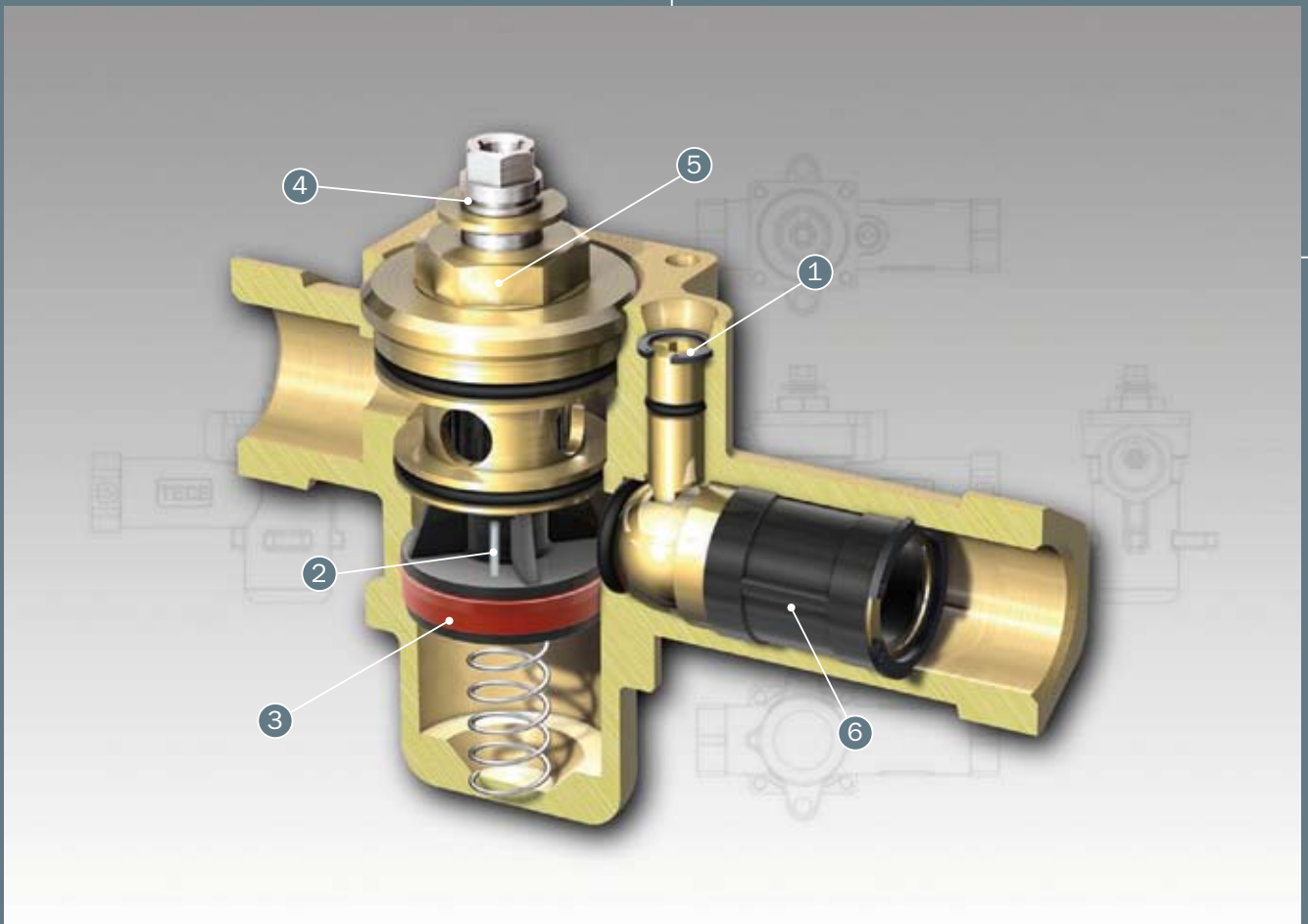

1. Inlet flow control
2. Automatic jet cleaning needle in flow zone
3. Robust wear-resistant plastic piston packing (no leather)
4. Flow volume adjusting slot (4/2/1 litres, factory setting 2 litres)
5. High-performance plastic internal rod packing
6. Sound absorber

Manual and electronic cartridges have the same flush valve housing and the same high flush performance of  $> 0.3$  l/s at 1 bar. The flush valve can be set for a 1 litre economy flush volume. The flush volume remains constant, irrespective of the pipe pressure. Flush valve in accordance with DIN EN 12541.



# TECEprofil urinal module

**Like all modules in the TECEprofil pre-wall system, the TECEprofil urinal module with flush valve housing can be used in any situation.**

The module is suitable for all manual and electronic push plates from TECE. Like all TECE modules, it can be installed in the TECEprofil pre-wall systems and in wooden or metal post-and-beam walls. It can also be installed as an individual or corner module. The urinal flush valve housing is also available for brick-wall construction.

## Professionally assembled – safe and reliable operation.

### For brick-wall and dry-wall construction

The TECE urinal flush valve is available for brick-wall and dry-wall construction. In the case of dry-wall construction, it is assembled with the TECE urinal modules.

### Special bare wall protection – for dry walls

For both brick-wall and dry-wall construction, the TECE urinal flushing system provides a bare wall, soft plastic protector for dry walls. The bare wall protector is cut flush to the tiles during fine installation. As a result, water can only be discharged to the outside, and any defects are immediately visible.



The waterproof plastic bare wall protector prevents water from seeping behind the wall.



During the fine installation process, the plastic bare wall protector is cut flush to the tiles using a Stanley knife.



### TECEprofil urinal module with TECE flush valve housing

For installation in a TECEprofil pre-wall installation, to accommodate manual and electronic actuation systems.



# Electronic toilet flush valve from TECE



TECE offers three electronic actuation variants to match the universal cistern: cable, wireless or infrared actuation. All three versions are available with battery or mains operation. The electronic push plate works with a servo-motor that is operated with commercially available 6 volt lithium batteries or a 12 volt power supply unit. Around 25,000 flushes are possible with battery operation.

## **Non-contact flush**

Non-contact toilet flush actuation is more hygienic than a manual flush, and makes sense in all public sanitary facilities. However, this clean solution is often passed up because frequent over-actuation of the flush increases water consumption. The infrared electronics from TECE are therefore based on an autofocus sensor. The sensor reliably detects whether someone is standing or sitting. The flush is therefore rarely actuated by mistake. The matching push plate from the TECEplanus range enables manual flushing in addition to the non-contact option.

## Toilet electronics from TECE – comfortable flush actuation.



## **Simple retrofitting**

The battery-operated electronics can be easily retrofitted to installed TECE cisterns. The TECE cistern splash guard is simply replaced by a splash guard with motor.



TECE offers cable and wireless flush actuation especially for barrier-free toilets. With cable-connected operation, the flush can be actuated on the safety support arm or wall. With radio control, it is possible to actuate the flush at any point within the electronic system's reception range. Manual actuation of the push plate is always possible as well.

The radio-based toilet electronics are compatible with radio switches on the safety support arms from HEWI, Keuco, Lehnert, Normbau, pba, or Pressalit. Installation is easy: The radio switch and toilet electronics only need to be fine tuned to each other once.

**Toilet remote radio-controlled actuation  
for safety support arms**

Battery operation, 6 V

**Toilet remote radio-controlled actuation  
for safety support arms**

Mains operation, 230/12 V

**Toilet remote actuation  
for cable-connected electric switch**

Battery operation, 6 V

**Toilet remote actuation  
for cable-connected electric switch**

Mains operation, 230/12 V

## Barrier-free solutions from TECE – durable, functional, simple.

### TECE Geronto module – for universal use

The Geronto module is especially developed for the installation of barrier-free toilets. It is based on the universal toilet module in the TECEprofil range. With pre-assembled conduits for cabling, the Geronto module simplifies installation of flush actuation on the safety support arm.

TECE offers matching steel plates for standard-compliant, fast assembly of the safety support arms. There is a plate with predrilled, threaded holes for practically every safety support arm on the market. Assembly is easy: The plates can be screwed onto the basic frame with four fastening screws.



1. Steel plate set to attach safety support arms
2. Preassembled conduits
3. The distribution box on the cistern cover, which folds inwards, can be reached at all times
4. Stable crossbeam with riveted thread – to hold the ceramics securely even under heavy loads; the preset seat height is 48 cm

**TECEprofil toilet Geronto modular system to accommodate safety support arms**

**Steel plate set TECEprofil to hold the safety support arms from a range of manufacturers**

Consisting of two steel plates for attachment to the Geronto module. For more information, please see our assortment list.

# Perfect partners in toilet hygiene.

**TECE has concluded a strategic partnership with Japanese sanitation ceramics manufacturer TOTO.**

TOTO, world market leader for washlets, has developed wall-hung washlets especially for the European market. The flushing technology is supplied by TECE: Toilet module with TECE cistern and TECEloop push plate. The TECE universal module is upgraded for TOTO washlets with the help of a shell set. The set contains a sound-insulated wall disk for water connection, a power connection with retaining plate and a hollow-wall box.



## **Upgrade set for TECEprofil standard modules**

Shell set for TOTO  
Washlet incl. sound-insu-  
lated wall disk for water  
connection, power con-  
nection with retaining  
plate and hollow-wall box.



## TECEprofil modules for TOTO washlets



### **TECEprofil toilet module for TOTO Neorest washlet**

Remote actuation possible for the washlet. With control cable for electronic flush actuation, hollow-wall box and sound-insulated wall disk.

TECE offers a module with a concealed cistern for the top model among TOTO's washlets – Neorest. The prefabricated unit has automatic flushing, which can be directly connected to the washlet. The ceramics and motor with special actuation on the basis of the TECEloop push plate are sold by TOTO Europe GmbH in Düsseldorf via specialist wholesalers.



**The TECE toilet module with odour extraction includes a connection for the ventilation system directly on the flush pipe.**

Odours are extracted with the room fan via the flush openings in the toilet ceramics. The TECE system therefore extracts the odours directly where they occur – at the toilet. The DN 70 connection on the module is compatible with all standard fans on the market. Assembly is quick and easy and complies with standards.

**TECEprofil universal module with odour extraction**

For installation in a TECEprofil pre-wall or as individual module.

## Simple solution for odour-free toilets.

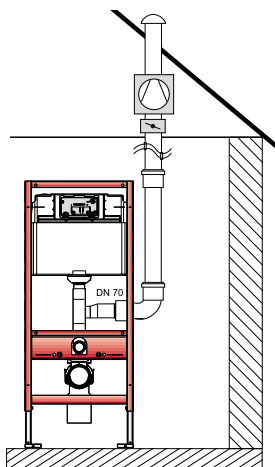

Odour extraction with central extraction/controlled room ventilation

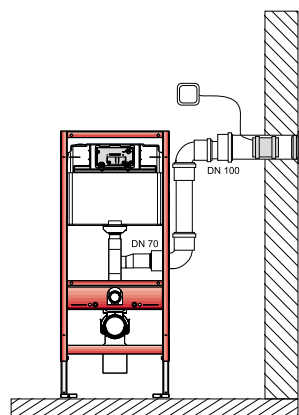

Odour extraction with in-duct fan

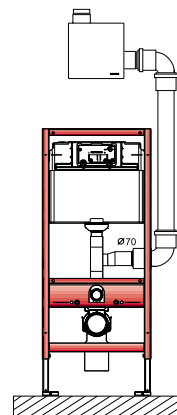

Odour extraction on second room connection

**Universal use for different ventilation systems**



# TECEprofil module with odour extraction

In toilet areas without an outside wall in multi-family houses, the toilet element can be easily connected to the room fan (fig. left) . This is achieved using the existing DN 70 connection sleeve, which permits connection to the concealed housing with the second room connector by means of plastic pipes. The large cross-section of 70 mm ensures a low air speed and permits effective, draught-free odour extraction. The dampness in the extracted air condenses on the inner wall of the exhaust air pipe before it reaches the fan.

The toilet element with odour extraction can also be used in a single-family house too (fig. below). If the bathroom has an outside wall, the extraction pipe of the toilet element is connected with an in-duct fan. As a result, odour extraction can be implemented in a straightforward way – without adverse effects such as a temperature drop caused by opening the window, which in turn leads to higher heating costs.

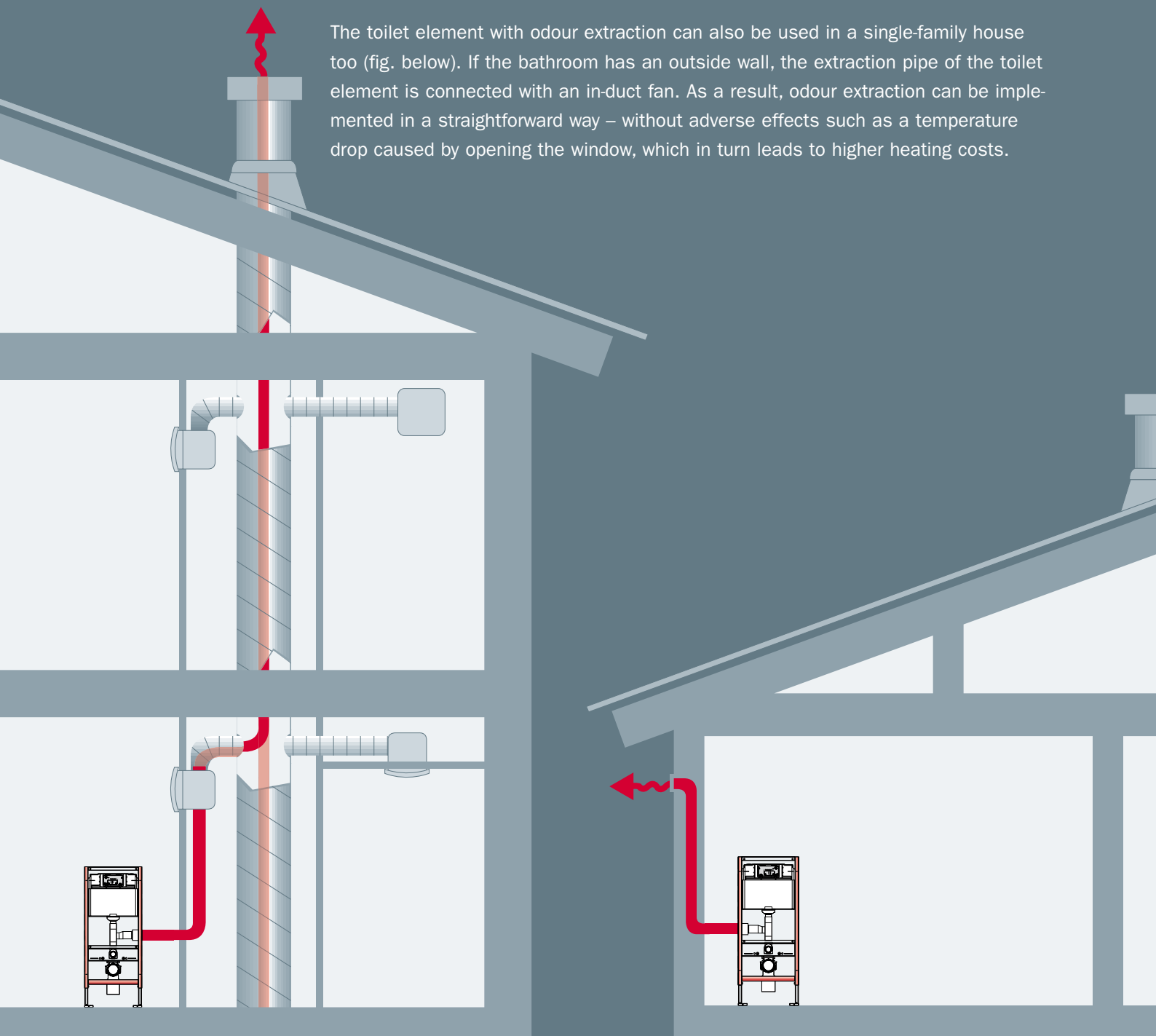

# Intelligent flushing technology – made by TECE.

## **TECE GmbH**

International Business

Hollefeldstraße 57  
48282 Emsdetten  
Germany

Phone +49 (0) 25 72 / 928 999

Fax +49 (0) 25 72 / 928 204

international-business@tece.de

[www.tece.biz](http://www.tece.biz)



DS030\_002\_13 a

# TECE:

Intelligent housing technology